

SPAZZOLINI E ASTE DI COLLEGAMENTO

STRIPS AND CONNECTION ROD

BROSSE ET TIGE DE RACCORDEMENT

CEPILLO Y PLETINA DE CONEXIÓN

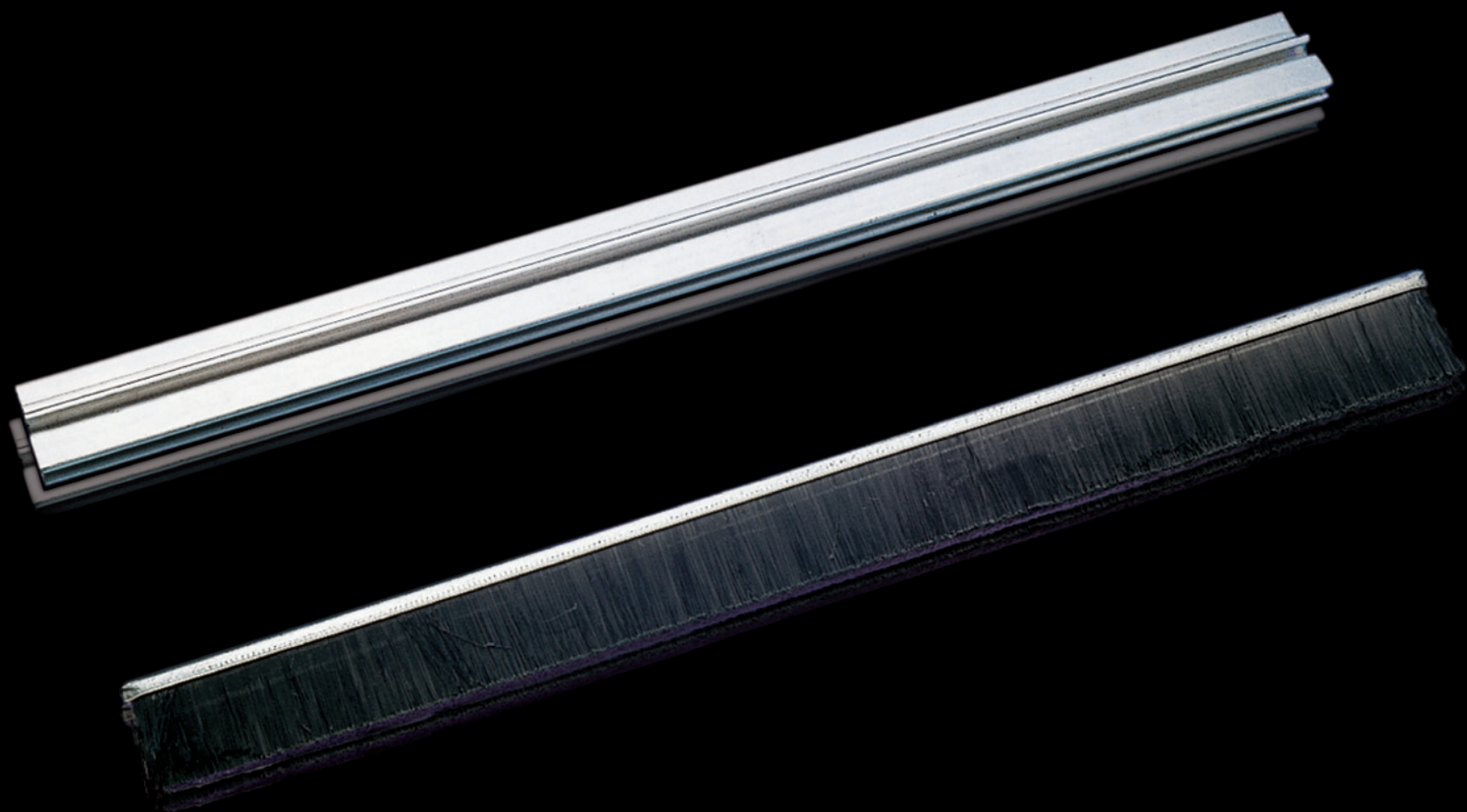

# RISCONTRO PER CHIUSURA REGOLABILE

ART. 0159 - ART. 0160 - ART. 0161 - ART. 0162  
ART. 0170 - ART. 0171 - ART. 0172



**I Spazzolino antispiffero**  
Spazzola universale antispiffero con supporto. Montaggio a 90° o 180° (vedi disegno). Utilizzabile su porte e portoni scorrevoli e girevoli. Non blocca la porta poichè segue le asperità del terreno. Si applica facilmente a qualsiasi tipo di porta (alluminio, ferro, legno).

**GB Anti-draught brush strip**  
Anti-draught brush strip with mount. For all profiles. Can be mounted at 90° or 180°(see drawing) Suitable for sliding and rotating doors, Conform to floor and wan't cause sticking Easily fitted to all types of door (aluminium, steel, wood)

**FR Brosse**  
La brosse universelle 90°/180° C'est la solution pour les problèmes de blocage sur portes coulissantes ou pivotantes. Elle peut s'appliquer à tout le type de porte (aluminium, fer, bois).

**E Cepillo**  
El cepillo universal a 90°/180° es la solución para los problemas del bloqueo en puertas correderas y abatibles sin marco inferior. No bloquea la puerta y es de fácil aplicación en cualquier tipo de puerta (aluminio, hierro, madera).

134

**ART.**

**0159**

Supporto in alluminio  
Aluminium mount

Bâti d'aluminium  
Soporte aluminio



50

**0160**

Strip H 15 mm  
Strip H 15 mm

Strip H 15 mm  
Strip H 15 mm

50

**0161**

Strip H 23 mm  
Strip H 23 mm

Strip H 23 mm  
Strip H 23 mm

50

**0162**

Strip H 30 mm  
Strip H 30 mm

Strip H 30 mm  
Strip H 30 mm

50

**0170**

Completo H 15 mm  
Completo H 15 mm

Completo H 15 mm  
Completo H 15 mm

50

**0171**

Completo H 23 mm  
Completo H 23 mm

Completo H 23 mm  
Completo H 23 mm

50

**0172**

Completo H 30 mm  
Completo H 30 mm

Completo H 30 mm  
Completo H 30 mm

50

Supporto in alluminio  
Aluminium mount  
Bâti d'aluminium  
Soporte aluminio

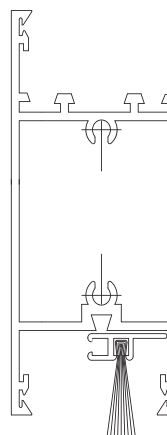
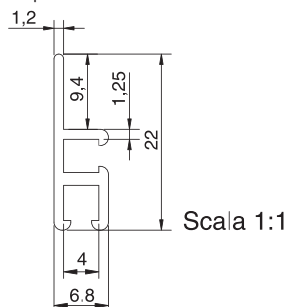

Montaggio a 90°  
90° configuration  
Configuration a 90°  
Montaje a 90°

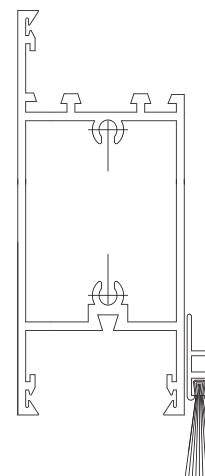

Montaggio a 180°  
180° configuration  
Configuration a 180°  
Montaje a 180°

Per commissionare la spazzola è opportuno conoscere:  
H = altezza totale

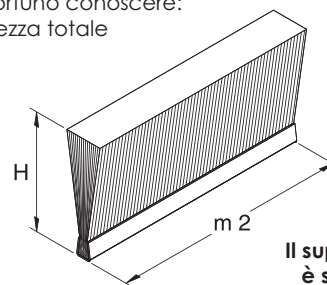

**Il supporto in alluminio è sempre disponibile nella lunghezza di mm.2000**

Profili - Profiles - Profilés - Perfiles

0159 0160 0161 0170 0171

■	■	■	ALL.CO 5 - K 40
■	■	■	ALCOA R 40
■	■	■	EKU
■	■	■	GOLD 400/490/500/600
■	■	■	METRA

# SPAZZOLINO PER SCORREVOLE

ART. 0173 - ART. 0174 - ART. 0176



**I** Spazzolino per scorrevole "SUPERFIN BLACK"  
Senza pinna centrale.  
**ART. 0173** 4.8 x 5.5 mm  
**ART. 0174** 6.9 x 7 mm  
Con pinna centrale  
**ART. 0176** 6.9 x 5.5 mm

**GB** "SUPERFIN BLACK" brush strip for sliding systems  
Without inner core.  
**ART. 0173** 4.8 x 5.5 mm  
**ART. 0174** 6.9 x 7 mm  
With inner core.  
**ART. 0176** 6.9 x 5.5 mm

**FR** Brosse pour coulissantes systèmes "SUPERFIN BLACK"  
Sans aileron centrale.  
**ART. 0173** 4.8 x 5.5 mm  
**ART. 0174** 6.9 x 7 mm  
Avec aileron centrale.  
**ART. 0176** 6.9 x 5.5 mm

**E** Cepillo para correderas sistema "SUPERFIN BLACK"  
Sin pala central.  
**ART. 0173** 4.8 x 5.5 mm  
**ART. 0174** 6.9 x 7 mm  
Con pala central.  
**ART. 0176** 6.9 x 5.5 mm

ART. 0173

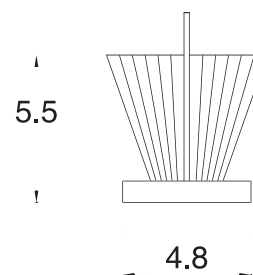

ART. 0174

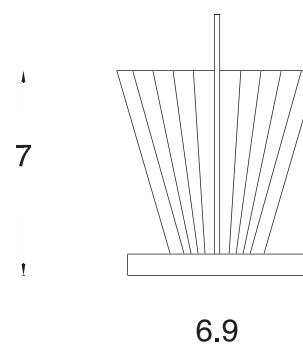

ART. 0176

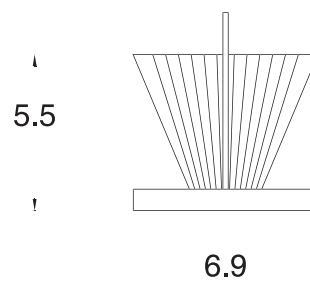

ART.



- |             |  |
|-------------|--|
| <b>0173</b> | Rotoli da 100 m. in scatole da 500 m<br>Coils of 100m. in boxes of 500m<br>Enroulements de 100 m en boîtes de 500 m<br>Bobinas de 100 m en cajas de 500m |
| <b>0174</b> | Rotoli da 100 m. in scatole da 500 m<br>Coils of 100m. in boxes of 500m<br>Enroulements de 100 m en boîtes de 500 m<br>Bobinas de 100 m en cajas de 500m |
| <b>0176</b> | Rotoli da 100 m. in scatole da 500 m<br>Coils of 100m. in boxes of 500m<br>Enroulements de 100 m en boîtes de 500 m<br>Bobinas de 100 m en cajas de 500m |



# ASTA DI COLLEGAMENTO

ART. 0175.1



- I **Asta di collocamento**  
Realizzata in poliammide caricata al 35% con fibra di vetro
- GB **Connection rod**  
Made from polyamide loaded with 35% glass fibre
- FR **Tige de raccordement**  
En polyamide dont le 35% est en fibre de verre
- E **Pletina de conexiòn**  
Hecho con polyamida con un 35% de fibra de vidrio

136

ART.



0175.1

Rotoli da 250 m.  
250 m. colis  
Bobine da 250 m.  
Bobinas de 250 m.

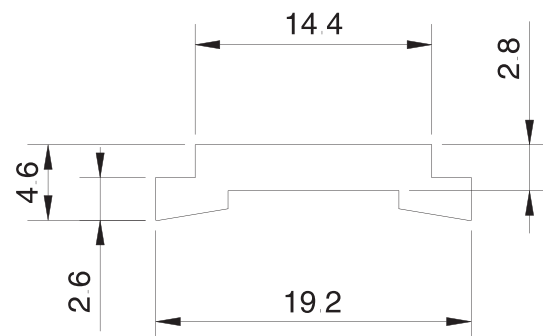

Profili - Profiles - Profilés - Perfiles

CAMERA EUROPEA

EUROPEAN GROOVE

GORGE EUROPEENNE

CAMARA EUROPEA

